



CORDLESS SPRAYER

RACPVD16L

USER GUIDE

CAUTION: Read this manual before using this machine!



CONTENTS

1. SAFETY INSTRUCTIONS.....	3
2. PRODUCT DESCRIPTION.....	7
3. PREPARATION BEFORE USE.....	8
4. HOW TO USE.....	10
5. AFTER-USE CHECK AND STORAGE.....	12
6. SELF-CHECK BEFORE ASKING SERVICE.....	13
7. PRODUCT SPECIFICATIONS.....	13
8. DECLARATION OF CONFORMITY.....	14
9. WARRANTY.....	15
10. PRODUCT FAILURE.....	16
11. WARRANTY EXCLUSIONS.....	17

1. SAFETY INSTRUCTIONS

- Safety precautions are safety precautions and safety precautions for safe use of rechargeable sprayers. Failure to observe these precautions can result in death, serious injury, product failure, or performance degradation.
- This sprayer is designed for forestry and agriculture use (lawns and gardens) to save the labour cost. It is not a household product, it is forbidden to use it for washing the body. All others use are prohibited.
- The sprayer shall be used only with plant protection products approved by local/national regulatory authorities for plant protection products for use with knapsack sprayers.
- Please read the manual before use and fully understand the contents before use.
- This is to prevent user's safety and property damage. Please read the following carefully and use it correctly.
- Wear personnel protective equipment which includes at least eyes protection, hearing protection, mask, antiskid footwear, safety clothing and gloves.
- The sprayer could be used by a first time inexperienced operator. However, the user should have training for all operations with a professional before use the machine.
- Secure the sprayer during transport to prevent damage or injury. Always transport the sprayer by its handle.
- Always bring maintenance and servicing to the sprayer after each use. Follow the instructions given in this manual and use accessories recommend by the fabricant. Improper maintenance, use of non-conforming components and removal of safety devices can raise the risk of accident, deterioration of the machine and bad result of operation.
- Warning – Do not use the sprayer while tired, ill or under influence of alcohol or other drugs or medicaments.
- During the operation, some hazards may be encountered; in order to avoid hazards, before, check the operation area, keep bystanders far away. Direct the spray lance downwind from the operator. Do not direct the lance on fire, dangerous products and materials.
- Do not use the spray in a closed room, in a dangerous area (by example area with the presence of chemical product, fire).
- In the event of accidents or blockages, stop immediately to use the tool. Remove the battery. Check the tool in case of damage. Remove the blockage in a safe way. If the tool is damaged, do not use it again and bring it to a service client.
- When restarting the sprayer after wintering: check the level of battery and charge it if necessary. Let the tool run in neutral for a few minutes.
- When a nozzle is blocked, stop to use the tool. Disassemble the nozzle and clean it to remove the blockage.
- Never come in contact with chemical products. In case of inhalation, stop to use the tool; go immediately in a place where fresh air is present. In case of contact with the skin, rinse abundantly with clean water. During use, filling, draining, cleaning or servicing, handle the lance in a safe way; avoid contact with chemical agent. Use protective gloves.
- Always use accessories and batteries recommended by the manufacturer. Contact the manufacturer for advice for spare parts and accessories (see in the end of this manual).
- Avoid drift taking into account different parameters such as nozzles, pressure, boom height, wind speed, etc.

- Do not use plant protection products
- Do not connect this sprayer to other equipment.
- The precautions are divided into three categories: "DANGER", "WARNING" and "CAUTION".

 <p>DANGER!</p>	<p>If there is a possibility of serious injury or death in case of violation of the indication</p>
 <p>WARNING!</p>	<p>If there is a possibility of serious injury or serious injury in case of violation of the indication</p>
 <p>CAUTION!</p>	<p>If there is a possibility of slight injury or damage to the product in violation of the marking</p>

Precautions before use

 **DANGER!** People who shall never use a sprayer:

- Drinkers and pregnant women
- People with mental illness

 **WARNING!**

- Do not handle the battery and charger with wet hands. There is a danger of electric shock.
- Do not use batteries that do not meet the specifications or modify the product.
- Before use, wear safety goggles and respiratory protection, wear suitable clothing.

 **CAUTION!**

- Check that there are no leaks in the assembling and connecting parts of each part, no cracks or leaks in the hoses, no abnormalities in the buckles of the shoulder straps and the tank connections.
- If you need to move to a vehicle with medicines in the medicine dispenser, drugs may leak out.
- Tighten the tank cap tightly to prevent the product from tilting. If the battery is damaged due to impact, it may be dangerous to remove the battery.
- Be sure to charge the battery after purchase and before and after use.

Precautions when using

 **DANGER!**

- If you use pesticides, please read the pesticide manual carefully and understand the toxicity and usage and mix them properly.
- If the pesticide reaches the skin while spraying the pesticide, stop work immediately and wipe the contaminated area clean with soap. If there is a lot of contamination, go to the nearest hospital and treat it.
- If the condition of your body is not good during pesticide application, stop work immediately and take enough rest.

- d. If the wind suddenly picks up during use, turn the sprayer in the direction of the wind and, if necessary, stop working.
- e. Considering the different parameters such as nozzles, pressure, spray height, wind speed, please follow our recommendations to choose the nozzle.

 **WARNING!**

- f. Please tighten the cap tightly so that the tank lid does not leak.
- g. Never mix pesticides with other containers, and empty containers should be disposed of properly.
- h. When spraying pesticides, prohibit workers from entering or exiting the machine, and be careful not to direct the nozzle to the person or animal.

 **CAUTION!**

- i. Do not put more than the capacity to be injected into the tank more than the capacity indication scale on the side of the tank.
- j. Thoroughly mix the medicines with appropriate amount and dilute them before putting them in the tank.
- k. If abnormal noise or leakage occurs in the sprayer during operation, immediately stop the operation and check the sprayer.

Notes after use

 **CAUTION!**

- a. After use, thoroughly remove any residual liquid in the tank and rinse thoroughly with clean water.
- b. After cleaning the tank, clean the filter, the inside of the hose, and the inside of the nozzle thoroughly for about 3 to 4 minutes.
- c. After use, please be sure to fully charge the battery and remove the mains connector jack.
- d. After use and cleaning, store your tool. Use the provided carton box to transport the sprayer and the accessories. Store the tool in a clean, dry place, preferably in its box.

 **DANGER!**

- e. Keep in a safe place out of the reach of children.

 **CAUTION!**

- f. When storing for a long time, please keep it completely dry. Please keep it in a cold room indoors especially in winter.
- g. After washing, operate until the water no longer comes out from the nozzle,

Long term storage precautions

- a. Please store. If moisture is left inside the pump and hose, it may be damaged by winter wave.
- b. After the battery is fully charged, disconnect the main unit connection jack and keep the operation switch OFF.

Battery and Charger Handling Precautions

 **WARNING!**











- a. Charge the battery with the standard charger included in this product.
- b. Charging with another charger that does not fit the capacity may cause fire or malfunction.
- c. The battery is a PASECO sprayer. Do not use batteries other than standard batteries. It may



- cause overheating and damage to the battery.
- d. Do not repair or modify the charger and battery. There is a danger of electric shock or fire. Be sure to apply for repair at the retailer you purchased or A / S.
- e. Charge the battery in a well-ventilated place where the temperature is between 0 ° C and 40 ° C.
- f. Do not cover the battery with paper or cloth while charging.
- g. Never put the battery in water or fire.
- h. Do not charge or use in the presence of flammable liquids or gases.
- i. Do not store the battery in a car in summer or in a place where the temperature rises more than 50° C.

 **CAUTION!**

- j. Do not touch the plug with wet hands when charging. There is a danger of electric shock.
- k. Always charge the battery as described in the manual.
- l. There is a risk of fire or explosion.
- m. When not using for a long time, be sure to keep the battery fully charged and charge the battery at least once every three months. After the battery is fully discharged, reuse (recharging) may not be possible.

Symbols explanation

 	To reduce the risk of injury, the user must read and understand this manual before using this product.
	Conforms to relevant safety standards.
  LI-ION	Do not dispose of old appliances with domestic rubbish.
	Wear eyes protection.
	Wear respiratory protection.
	Wear appropriate protective clothing.
	Recycling.
 Max 50°C	Do not expose batteries to temperatures exceeding 50 degrees.

	Do not dispose of batteries in water.
	Do not dispose of batteries in fire. They could explode and cause injury.
	keep bystanders away when spraying.

2. PRODUCT DESCRIPTION

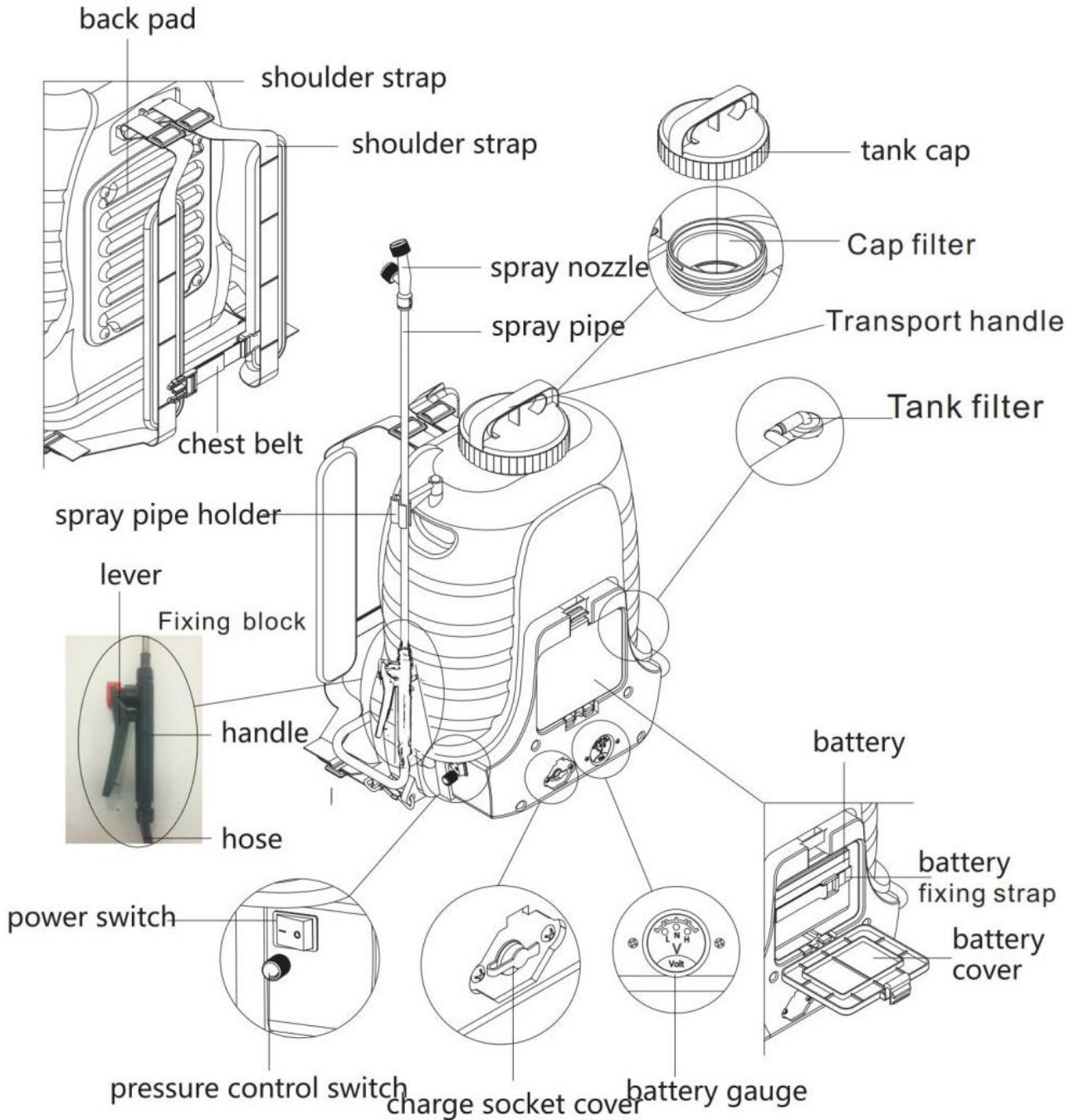

3. PREPARATION BEFORE USE

⚠ CAUTION! Make sure that there is a packing at the joined part as shown in the fig. Please join tightly so that the liquid would not leak

1) Unpacking and conformation of auxiliary parts

- Since all products go through test before shipping, there can be some water left in the sprayer main body and handle/hose assembly.

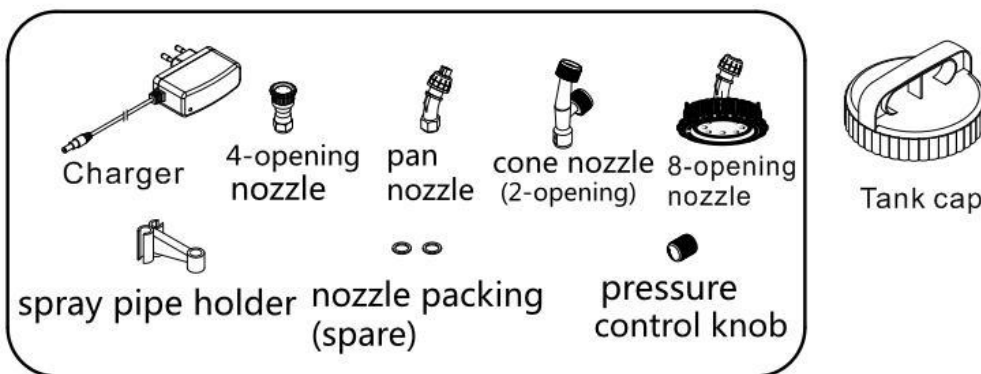
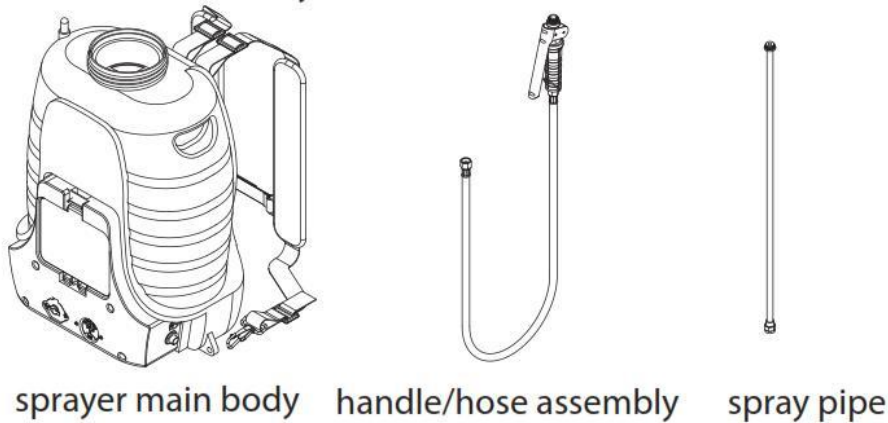

2) Assembly and preparation for use

- Assemble the spray pipe and nozzle as following:
Screw the spray pipe to the handle.
Screw the desired nozzle to the spray pipe.
- Please attach to the main body as follow:
 - a. Place the filter in the hole of the main body
 - b. Screw the tank cap to the main body.
 - c. Install the spray pipe holder to the main body.
 - d. Install the spray pipe into the spray pipe holder.
 - e. Join the buckle at the lower end of the shoulder strap as shown in the figure.
- Insert the pressure control knob to the pressure control switch shaft in the main body as shown in the figure.

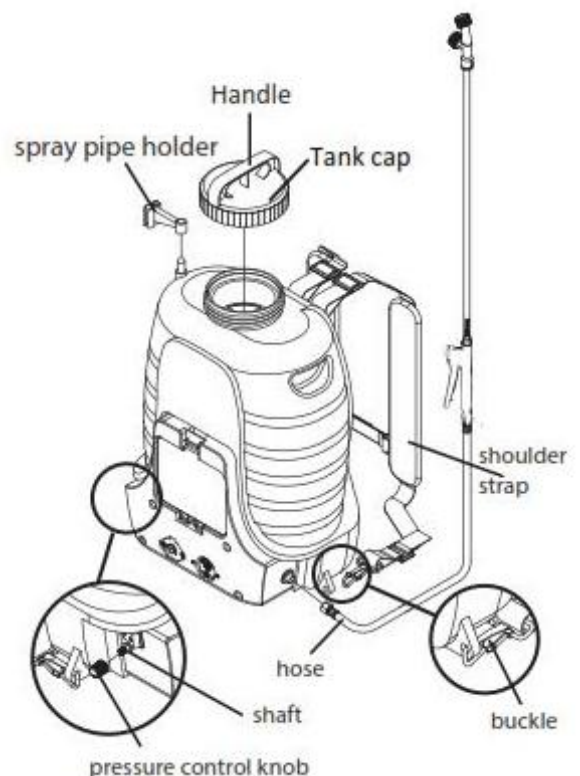

CAUTION! Please join the hose to the main body tightly so that the liquid would not leak.

CAUTION! A handle is located on the tank cap, it is used to lift and carry the full sprayer. Before use, adjust the shoulder strap as following.

- Make sure that the upper part and the lower part of the shoulder strap are not twisted and firmly joined.
- Adjust the length of the shoulder strap to the user. Use the length-adjusting strap in the lower end as shown in the figure.
- Adjust the chest belt to the user. Use the length-adjusting strap and join the buckle as shown in the figure.

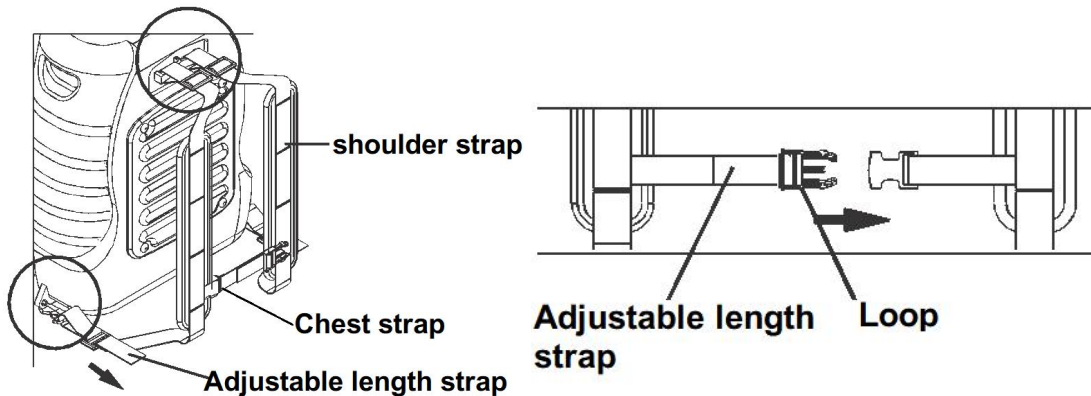

- If the shoulder strap is loose, the sprayer becomes heavier and work efficiency drops.
- Before use, always check that the upper part and the lower part of the shoulder strap are not twisted and firmly joined. If the shoulder strap would be untied during use, user may get personal injury.

Installation of the battery cover

- Insert the bottom of the cover in the hook situated below the frame of the battery compartment. Then close the cover by pushing the lever of the cover inside the hole situated on the top of the frame.

3) Battery charge and assembly

CAUTION! The battery is not fully charged when shipped. Before use, please correctly and fully charge the battery. Please use the charger provided with the product. Do not use other charger.

- Open the charge socket cover as shown in the figure.
- Plug in the charger included in the product to the 220V power outlet. The LED light of the charger would turn on in “green”.
- Insert the charge plug of the charger to the charge socket of the main body. The LED light of the charger would turn on in “red” and the charge starts.

CAUTION! It will take 7 to 8 hours for full charge. The LED light of the charger would turn from “red” to “green” when the charge has been completed.

- When the charge is finished, Disconnect the charging plug from the socket.
- Unplug the charger from the power outlet.

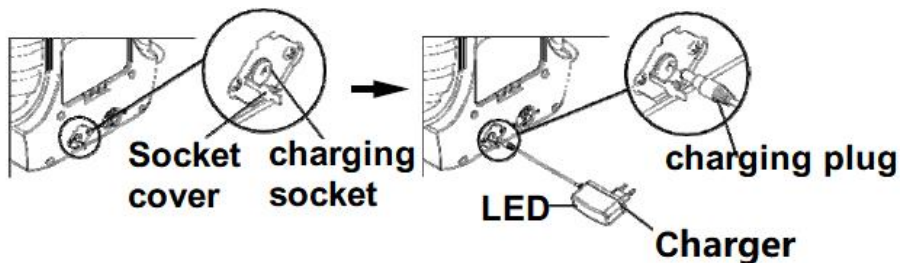

Battery charge gauge

The battery gauge indication is as following. Please correctly use it by checking the gauge during spraying or charging.

- When only “L” light is on: Voltage is low. Please charge the battery
- When “L” light and “N” light are on: The battery voltage is normal for use.
- When “L” light, “N” light and “H” light are all on:

The battery is in over-voltage status. If you are charging, please stop charging.



Battery gauge

4) Preparation of liquid and filling

CAUTION! Agricultural chemicals are hazardous. Always carefully read the cautions and use method given by the chemical manufacturers and abide by it during use.

- When filling the tank with liquid, always fill through the cap filter. If there is foreign substance or undiluted chemical in the liquid, it can clog the nozzle and cause the malfunction of the pump.
- When using water soluble powder or coal sulphur mixture, it should be sufficiently stirred. If not, it can clog the nozzle and cause the malfunction of the pump.
- Please take maximum care when using agricultural chemical. If chemical would be spilled on body, make sure to wash with fresh water completely.
- Make sure that the power switch and pressure control switch are at “OFF” position before filling.
- The capacity of the tank is 18L. Check the reading in the side of the tank while filing.
- When using different liquid, the tank inside should be completely washed by clean water.
- Then fill the tank with clean water and operate the sprayer for 3 to 4 minutes so that the inside of filter, hose, and nozzle would be well washed.
- After filling, close the tank cap tightly so that liquid would not leak.
- During filling, take the environment in consideration. Avoid any contamination. Fill the tool in a safe place and in a safe way.

4. HOW TO USE

There are a power switch and pressure control switch at the lower part of the tank side (this is left of you when you have the sprayer on your shoulder). You can use the sprayer in following two ways. Choose one as you wish.

- Using power switch with OFF/ON (high pressure) positions. If you push the power switch to “ON”, the sprayer starts as “high pressure”.
- Using pressure control switch, which has OFF, low pressure and high pressure.

If you turn the switch to the right, the pump starts. The more you turn to right, the higher the pressure goes. If you turn the switch to the end of the left, the pump stops at OFF.

Use this switch if you need specific level of pressure.

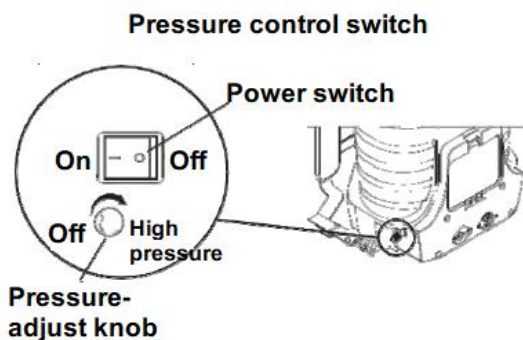

CAUTION!

- Please remember that the spray pressure is always “high pressure” when using the power switch.
- If you turned on the sprayer using the power switch, the pressure control switch does not work.
- If you want to control the pressure, turn off the sprayer by the power switch and turn on again using the pressure control switch.
- Pushing the lever allows liquid spraying from the nozzle as shown in the figure.
- If you want intermittent spraying, control the spray by the lever. If you want continuous spraying, use the fixing ring as shown in the figure.

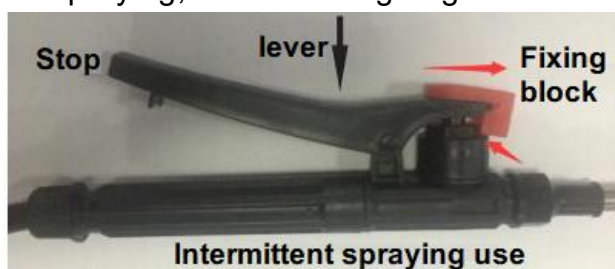

- We recommend spraying pressure as following.
 - a. High pressure spraying - water soluble powder, general chemical, pesticide spraying.
 - b. Low pressure spraying – herbicide spraying, indoor sterilization.
- Please always turn the power switch to OFF after spraying work. If you used pressure control switch, make sure to turn the switch to the far left to OFF position.
- Both the power switch and pressure control switch should be at OFF position when not in use.
- We provide with 4 kinds of nozzles. Please use one which fits to your use.

a. Cone nozzle (2 openings)

This nozzle sprays the liquid in circular shape as shown in the figure.

The spray particle is fine (small). It is good for pesticide and weed prevention. Cone nozzle is most generally used because it sprays liquid in most uniform manner. (Pressure 0.04-0.48Mpa, flow rate 0.58-1.85L/min)

b. Pan nozzle

This nozzle sprays the liquid in narrow oval shape as shown in the figure. It is good when spraying on at plane. It is good for herbicide and insect extermination. We recommend low pressure for herbicide so that the particle would be bigger; while we recommend high pressure for insecticide so that the particle would be smaller. (Pressure 0.02-0.46Mpa, flow rate 0.6-1.9L/min)

c. 4-opening nozzle

This nozzle sprays the liquid in small four circular shapes as shown in the figure. This nozzle can be adjusted. If you turn counter-clockwise, the spray particles become bigger. If you turn

clockwise, the particles become smaller.

We recommend this nozzle for insecticide on fruit trees because this nozzle sprays farther (to long distance) with bigger particles. (Pressure 0.01-0.56Mpa, flow rate 0.65-1.5 L/min)

d. 8-opening nozzle

This nozzle sprays the liquid in small eight circular shapes as shown in the figure.

We recommend this nozzle for insecticide on lawns because this nozzle sprays bigger areas.

(Pressure 0.0.1-0.46Mpa, flow rate 0.6-2.4 L/min)

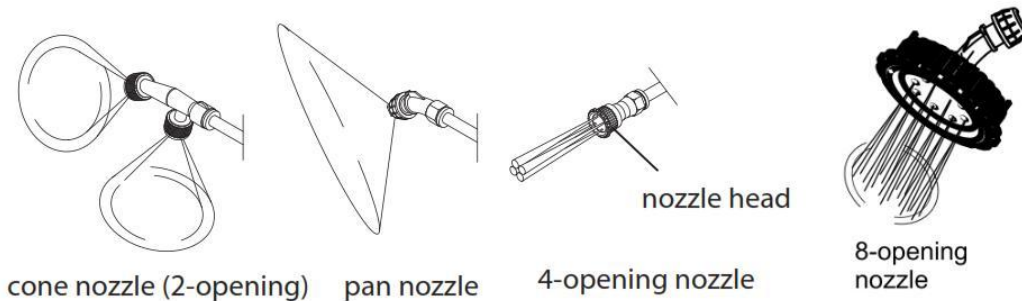

5. AFTER-USE CHECK AND STORAGE

1) After-use check

- Withdraw the liquid remaining in the tank. Wash the tank inside with clean water thoroughly.
- Fill the tank with fresh water and operate the pump for 3-4 minutes. Spray the water so that the inside of filter, hose and nozzle would be well washed.
- Turn o the power switch and pressure control switch after washing.

2) Daily check

- Check all joining parts and tighten. Make sure no part is untied and separated.
- Make sure there is no damage on the buckle and the connection parts of the shoulder strap.
- Make sure there is no damage on spraying hose and the connection parts between main body and the handle.
- Check for any foreign substance in the filters inside tank. Wash periodically. Refer to the figure below.
 - ◆ Open the tank cap and separate the cap filter.
 - ◆ Separate the tank filter from the nipple in the bottom of tank inside.
 - ◆ Separate the filter mesh from the filter body and clean it thoroughly.
 - ◆ After cleaning, attach the filter mesh to the inside groove of filter body and join it to the nipple.

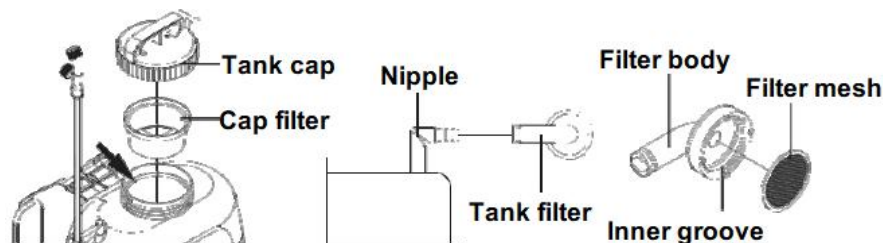

3) For long term storage

- Clean the sprayer following the sequence in the after-use check.
- The sprayer should be completely dried for long term storage. For winter, please store the sprayer indoor so that the pump and hose would not be damaged or cracked.
- The power switch and pressure switch should be OFF for storage.
- Please have the battery fully charged and separate it from charge socket in the main body for storage.

⚠ CAUTION! For storage longer than six months, the battery should be fully charged every 2-3 months. If the battery discharges completely, its life will quickly decrease and charging will be difficult.

⚠ CAUTION! The storage place should not get direct sunlight and has good ventilation.

⚠ CAUTION! The charger and battery should be kept in safe place not reachable by children.

6. SELF-CHECK BEFORE ASKING SERVICE

Please check following first before asking service (You should check following first to get faster and more accurate service)

Problem	Cause	What to do
Turn on the power switch but the pump does not start	<ul style="list-style-type: none"> • Battery discharged • Battery connection bad • Pump damaged 	<ul style="list-style-type: none"> • Charge battery • Check the charge socket connection in the main body • Check pump and replace if required (please ask service)
The pump works but there is no spray coming out	<ul style="list-style-type: none"> • The tank filter is clogged • There is no liquid in the tank • The nozzle is clogged 	<ul style="list-style-type: none"> • Clean tank filter • Fill with liquid • Clean nozzle
The pump abruptly stops while spraying	<ul style="list-style-type: none"> • The tank filter is clogged • There is no liquid in the tank • The nozzle is clogged • Battery has been discharged 	<ul style="list-style-type: none"> • Clean tank filter • Re fill liquid • Clean nozzle • Charge battery
Spray pressure is weak	<ul style="list-style-type: none"> • The tank filter is clogged • The nozzle is clogged • Battery has been discharged 	<ul style="list-style-type: none"> • Clean tank filter • Clean nozzle • Charge battery

7. PRODUCT SPECIFICATIONS

Product dimension

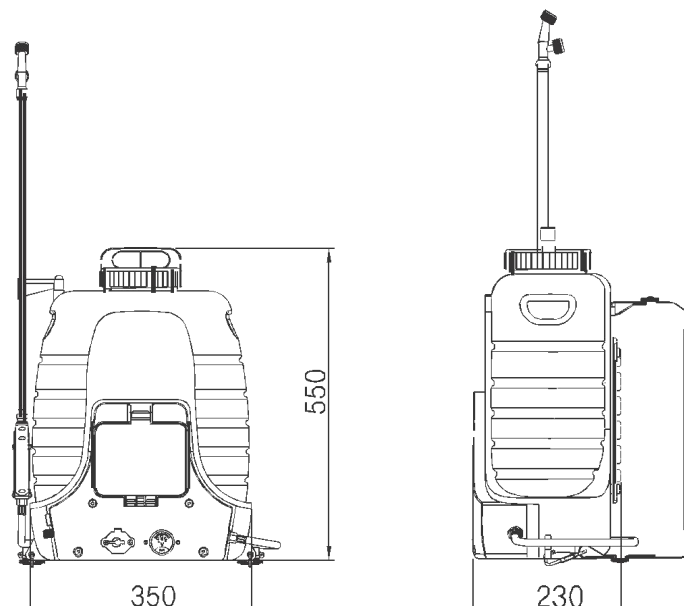

Product specification

Sprayer	Model	RACPVD16L
	Product size (mm)	350x230x550
	Product weight (kg)	Empty weight: 4,7 kg/ full weight: at least 5kg
	Tank capacity (L)	18
	Continuous use hours	About 5 hours (at high pressure)
	Spray quantity (@high pressure)	1.5 L/min. (2-opening cone nozzle basis)
Pump	Type	Diaphragm type
	Voltage	12V d.c.
	Maximum pressure	0.4Mpa
	Maximum flow	3.6 l/min
Battery	Type	Lithium ion
	Voltage	12V8Ah / Rated DC 11.1V, 88.8W
	Capacity	8Ah
Charger	Input voltage	100-240V~ 50/60Hz 0.2A Max
	Output voltage	12V d.c.
	Charge hours	7-8hours

8. DECLARATION OF CONFORMITY



BUILDER SAS

ZI, 32 RUE ARISTIDE BERGES – 312070 CUGNAUX – FRANCE

Declares that the machinery designated below : CORDLESS SPRAYER

Model: RACPVD16L

Serial number: 20241106251-20241110036

Complies with the provisions of the Directive « machinery » 2006/42/CE and national laws transposing it:

Also complies with the following European directives:

EMC Directive 2014/30/EU

LVD Directive 2014/35/EU

Also complies with European standards, with national standards and the following provisions

EN ISO 12100:2010, EN ISO 19932-1:2013, EN ISO 19932-2:2013,

EN 60204-1:2018

EN IEC61000-6-1:2019, EN IEC61000-6-3:2021,

EN 60335-1:2012+A11:2014+A13:2017+A1:2019+A14:2019+A2:2019

EN 62233:2008; EN55014-1:2017;EN55014-2:2015

EN IEC61000-3-2:2019+A1:2021, EN 61000-3-3:2013+A1:2019+A2:2021

Done at Cugnaux, 27/08/2024

Philippe MARIE / PDG

9. WARRANTY

The manufacturer guarantees the product against defects in material and workmanship for a period of 2 years from the date of the original purchase. It can be extended by one year if the user subscribes to website of myswap. The warranty only applies if the product is for household use. The warranty does not cover breakdowns due to normal wear and tear.

The manufacturer agrees to replace parts identified as defective by the designated distributor. The manufacturer does not accept responsibility for the replacement of the machine, in whole or in part, and/or ensuing damage.

The warranty does not cover breakdowns due to:

- insufficient maintenance.
- abnormal assembly, adjustment or operations of the product.
- parts subject to normal wear and tear.

The warranty does not extend to:

- shipping and packaging costs.
- using the tool for a purpose other than that for which it was designed.
- the use and maintenance of the machine done in a manner not described in the user manual.

Due to our policy of continuous product improvement, we reserve the right to alter or change specifications without notice. Consequently, the product may be different from the information contained therein, but a modification will be undertaken without notice if it is recognized as an improvement of the preceding characteristic.

READ THE MANUAL CAREFULLY BEFORE USING THE MACHINE.

When ordering spare parts, please indicate the part number or code, you can find this in the spare parts list in this manual. Keep the purchase receipt; without it, the warranty is invalid. To help you with your product, we invite you to contact us by phone or via our website:

+33 (0)9.70.75.30.30

<https://services.swap-europe.com/contact>

You must create a "ticket" via the web platform.

- Register or create your account.
- Indicate the reference of the tool.
- Choose the subject of your request.
- Describe your problem.

Attach these files: invoice or sales receipt, photo of the identification plate (serial number), photo of the part you need (for example: pins on the transformer plug which are broken).



swap

10. PRODUCT FAILURE

WHAT TO DO IF MY MACHINE BREAKS DOWN?

If you bought your product in a store:

- Make sure that your machine is complete with all accessories supplied, and clean! If this is not the case, the repairer will refuse the machine.
- Go to the store with the complete machine and with the receipt or invoice.

If you bought your product on a website:

- Make sure that your machine is complete with all accessories supplied, and clean! If this is not the case, the repairer will refuse the machine.
- Create a SWAP-Europe service ticket on the site: <https://services.swap-europe.com> When making the request on SWAP-Europe, you must attach the invoice and the photo of the nameplate (serial number).

Contact the repair station to make sure it is available before dropping off the machine.

Go to the repair station with the complete machine packed, accompanied by the purchase invoice and the station support sheet downloadable after the service request is completed on the SWAP-Europe site

Please keep your original packaging to allow for after-sales service returns or pack your machine with a similar cardboard box of the same dimensions.

For any question concerning our after-sales service you can make a request on our website <https://services.swap-europe.com>

Our hotline remains available at +33 (9) 70 75 30 30.



11. WARRANTY EXCLUSIONS

THE WARRANTY DOES NOT COVER:

- Start-up and setting up of the product.
- Damage resulting from normal wear and tear of the product.
- Damage resulting from improper use of the product.
- Damage resulting from assembly or start-up not in accordance with the user manual.
- Periodic and standard maintenance events.
- Actions of modification and dismantling that directly void the warranty.
- Products whose original authentication marking (brand, serial number) has been degraded, altered or withdrawn.
- Replacement of consumables.
- The use of non-original parts.
- Breakage of parts following impacts or projections.
- Accessories breakdowns.
- Defects and their consequences linked to any external cause.
- Loss of components and loss due to insufficient screwing.
- Cutting components and any damage related to the loosening of parts.
- Overload or overheating.
- Poor power supply quality: faulty voltage, voltage error, etc.
- Damages resulting from the deprivation of enjoyment of the product during the time necessary for repairs and more generally the costs related to the immobilization of the product.
- The costs of a second opinion established by a third party following an estimate by a SWAP-Europe repair station
- The use of a product which would show a defect or a breakage which was not the subject of an immediate report and/or repair with the services of SWAP-Europe.
- Deterioration linked to transport and storage*.

* In accordance with transport legislation, damage related to transport must be declared to carriers within 48 hours maximum after observation by registered letter with acknowledgement of receipt. This document is a supplement to your notice, a non-exhaustive list.

Attention: all orders must be checked in the presence of the delivery person. In case of refusal by the delivery person, it you must simply refuse the delivery and notify your refusal.

Reminder: the reserves do not exclude the notification by registered letter with acknowledgement within 72 hours.

Information:

Thermal devices must be wintered each season (service available on the SWAP-Europe site). Batteries must be charged before being stored.



BUILDER SAS
32 rue Aristide Bergès - Z.I. du Casque - 31270 Cugnaux - France
MADE IN PRC